

15" LCD Television

FLM-1512



20060216

Polaroid. Add a little color to your life.

Since 1937, America has turned to Polaroid for their photography needs. Today, families look to Polaroid for consumer electronics that define the digital age: plasma and LCD TVs, portable and standard DVD players, digital cameras. And while our selection has changed, you'll still receive the same friendly, helpful service that made Polaroid an American icon. Congratulations on your new Polaroid LCD TV purchase. To ensure your new LCD TV provides you with years of enjoyment, please read this guide carefully.

Instruction Manual

WARNING

To reduce the risk of fire or electric shock, do not expose this product to rain or moisture.

Apparatus shall not be exposed to dripping or splashing and no objects filled with liquids, such as vases, shall be placed on the apparatus.

CAUTION

RISK OF ELECTRIC SHOCK.
DONOT OPEN

Caution: To reduce the risk of electric shock, do not remove cover (or back). No user serviceable parts inside. Refer servicing to qualified service personnel.



This symbol indicates "dangerous voltage" inside the product that presents a risk of electric shock or personal injury.



This symbol indicates important instructions accompanying the product.



Caution: To prevent electric shock, plug the 3-pronged plug into a grounded outlet.

Refer to the identification/rating label located on the back panel of your product for its proper operating voltage.

FCC Regulations state that unauthorized changes or modifications to this equipment may void the user's authority to operate it.

Caution: Using video games or any external accessory with fixed images for extended periods of time can cause them to be permanently imprinted on the LCD panel (or projection TV picture tubes). ALSO, some network/program logos, phone numbers, etc. may cause similar damage. This damage is not covered by your warranty.

Cable TV installer: This reminder is provided to call your attention to Article 820-40 of the National Electrical Code (Section 54 of the Canadian Electrical Code, Part 1), which provides guidelines for proper grounding and, in particular, specifies that the cable ground shall be connected to the grounding system of the building as close to the point of cable entry as practical.

Product Information

Keep your sales receipt to obtain warranty parts and service and for proof of purchase. Attach it here and record the serial and model numbers in case you need them. These numbers are located on the back of your LCD color television.

Model No. _____

Serial No. _____

Purchase Date: _____

Dealer/Address/Phone: _____

Instruction Manual

IMPORTANT SAFETY INSTRUCTIONS

1. Read these instructions.
2. Keep these instructions.
3. Heed all warnings.
4. Follow all instructions.
5. Do not use this apparatus near water.
6. Clean only with dry cloth.
7. Do not block any ventilation openings. Install in accordance with the manufacturer's instructions.
8. Do not install near any heat sources such as radiators, heat registers, stoves, or other apparatus (including amplifiers) that produce heat.
9. Do not defeat the safety purpose of the polarized or grounding-type plug. A polarized plug has two blades with one wider than the other. A grounding type plug has two blades and a third grounding prong. The wide blade or third prong is provided for your safety. If the provided plug does not fit into your outlet, consult an electrician for replacement of the obsolete outlet.
10. Protect the power cord from being walked on or pinched particularly at plugs, convenience receptacles, and the point where they exit from the apparatus.
11. Only use attachments/accessories specified by the manufacturer.
12. Use only the cart, stand, tripod, bracket, or table specified by the manufacturer, or sold with the apparatus. When a cart is used, use caution when moving the cart/apparatus combination to avoid injury from tip-over.
13. Unplug this apparatus during lightning storms or when unused for long periods of time.
14. Refer all servicing to qualified service personnel. Servicing is required when the apparatus has been damaged in any way, such as power-supply cord or plug is damaged, liquid has been spilled or objects have fallen into the apparatus, the apparatus has been exposed to rain or moisture, does not operate normally, or has been dropped.
15. Warning: This unit should only be serviced by an authorized and properly trained technician. Opening the cover or other attempts by the user to service this unit may result in serious injury or death from electrical shock, and may increase the risk of fire.



Instruction Manual

FCC Warning

Class B Computing Device Information to User

This equipment has been tested and found to comply with the limits for a Class B Digital Device pursuant to part 15 of FCC Rules. These limits are designed to provide reasonable protection against harmful interference in a residential installation. This equipment generates, uses, and can radiate radio frequency energy and, if not installed and used in accordance with the instructions, may cause harmful interference to radio communications. However, there is no guarantee that interference will not occur in a particular installation. If this equipment does cause harmful interference to radio or TV reception, which can be determined by turning the equipment off and on, the user is encouraged to try to correct the interference by one or more of the following measures:

- 1) Reorient or relocate the receiving antenna.
- 2) Increase the separation between the equipment and unit.
- 3) Connect the equipment into an outlet on a circuit different from that to which the unit is connected.
- 4) Consult the dealer or an experienced radio/TV technician for help and for additional suggestions.

The user may find the following booklet prepared by the Federal Communications Commission helpful: "How to Identify and Resolve Radio - TV Interference Problems". This booklet is available from the US Government Printing Office, Washington, D.C. 20402, and Stock No. 004-000-00345-4.

FCC Warning

The user is cautioned that changes or modifications not expressly approved by the manufacturer could void the user's authority to operate the equipment.

NOTE: In order for an installation of the product to maintain compliance with the limits for a Class B Device, shielded cables must be used.

PACKING LIST

LCD TV	1
Operation Manual	1
Power Adapter	1
AC Power Cable	1
Infrared Remote Control	1
Remote Control Battery	2
Warranty Card	1
Quick Start Guide	1

Note:

Please keep the original box and packaging for transporting the set in the future.

GENERAL INFORMATION

- Radio Frequency input; supports CATV
Capable of receiving cable programs in 470MHz, it can store 181 TV channels
- AV input
Convenient for watching a DVD player, VCR, video camera or other playback devices.
- S-Video input
Convenient of receiving a high quality component signal from a DVD player
- HDTV input
Capable of receiving the high definition YPbPr signal in 480i, 480P, 576i, 576P, 720P (50/60Hz), 1080i (50/60Hz), and 1080P (50/60Hz) formats
- MTS Stereo Decoding Function
Capable of identifying MTS automatically and reproducing high quality stereo sound.
- D-sub input
 - a. Convenient to connect with a host computer
 - b. Use as a data display terminal
 - c. Connect the 3.5mm (diameter) audio jack to your computer's soundcard to listen to stereo sound transmitted from your home computer
- Program & Child Lock
Capable of blocking inappropriate programs and the function button on the front panel.
- Timer function
In PC mode, it will enter into the Power Energy Saving Mode if there is no signal input. When a valid signal is received, it will automatically turn on again

- Blue background with noise reduction
In AV S-VIDEO and YPbPr modes, screen displays soft blue background if there is no signal input
- Multi Language On-Screen Display menu
Text and graphical user interface makes the menu operation user-friendly
- Power Energy Saving Mode (Power management mode)
When used as PC display terminal without PC signal output, the LCD TV will automatically power off within 30 seconds and enter Power Energy Saving Mode. It will automatically start up again when it receives a signal from the PC. To start the TV manually with no signal press the number buttons or /CH+/CH- on the remote control 
- Plug and Play
No additional software is needed when the product is used as computer terminal display
- Automatic picture quality adjustment
- Power management mode
- Auto on timer
- Zoom mode
Full-screen, 16:9, cinema, subtitle
- Low power consumption
- Picture enhancement function
Dynamic adjustment: improve anamorphic video to make it more appealing
Black field prolongation: darken black sections of a picture to enhance contrast in dim backgrounds
Colorful edge adjustment: increase edge gradient of color signals to make silhouettes clearer
Brightness edge adjustment: increase edge gradient of brightness signals to make silhouettes clearer
- High definition display panel
- Dynamic comb filter
- Headphone output
- CCD Function
- MARCOVISION auto identification function

INTRODUCTION

Front Panel

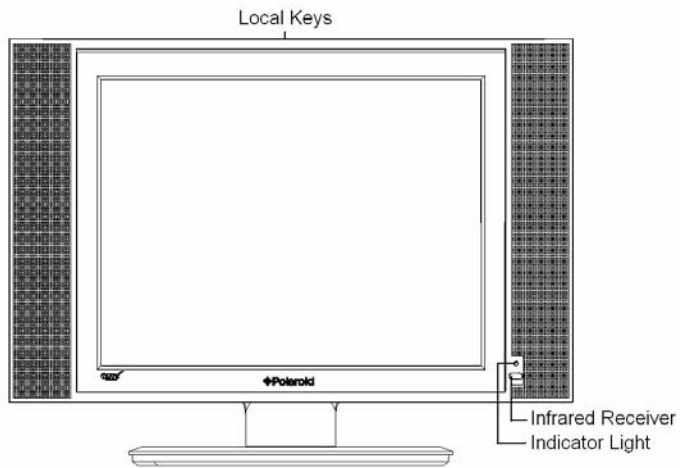

The button names and functions are as follows:

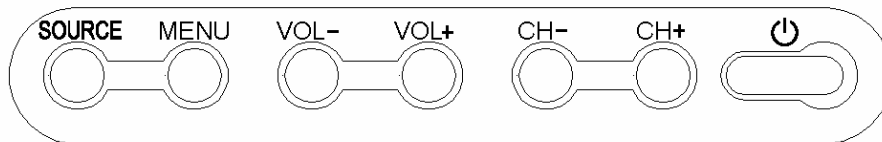

Panel buttons

Button	Description
SOURCE	To switch between TV, AV, S-Video, YPbPr and PC signal sources. The same function as SOURCE on R/C (remote control) in menu operation.
MENU	To enter or quit from the OSD (On-Screen Display) menu. The same function as MENU on R/C
VOL-	To decrease the sound volume. Adjust functions in menu operation. The same function as Vol- on the R/C
VOL+	To increase the sound volume. Adjust functions in menu operation. The same function as Vol+ on R/C
CH-	1. In TV mode, decrease the channel number 2. To select functions in menu operation. 3. The same function as CH- on the R/C
CH+	1. In TV mode, increase the channel number 2. To select functions in menu operation. 3. The same function as CH+ on R/C
⏻	To power on or put the LCD TV to STANDBY The same function as ⏻ on R/C

Rear Panel

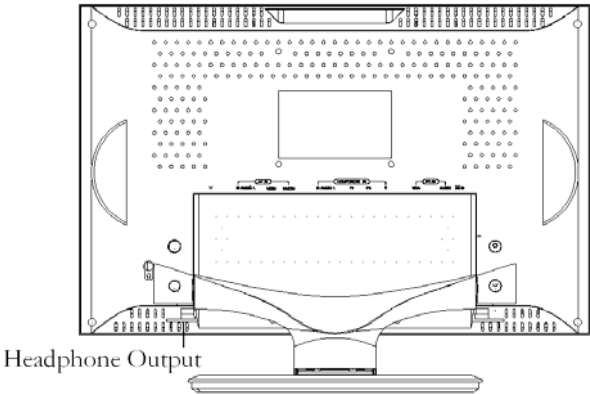

Detail Illustration of Signal Input Ports

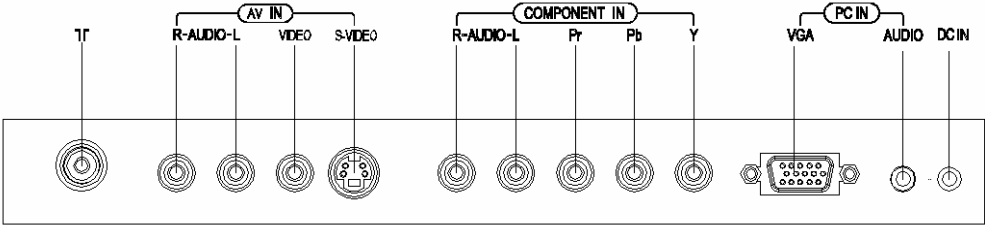

Remote Control

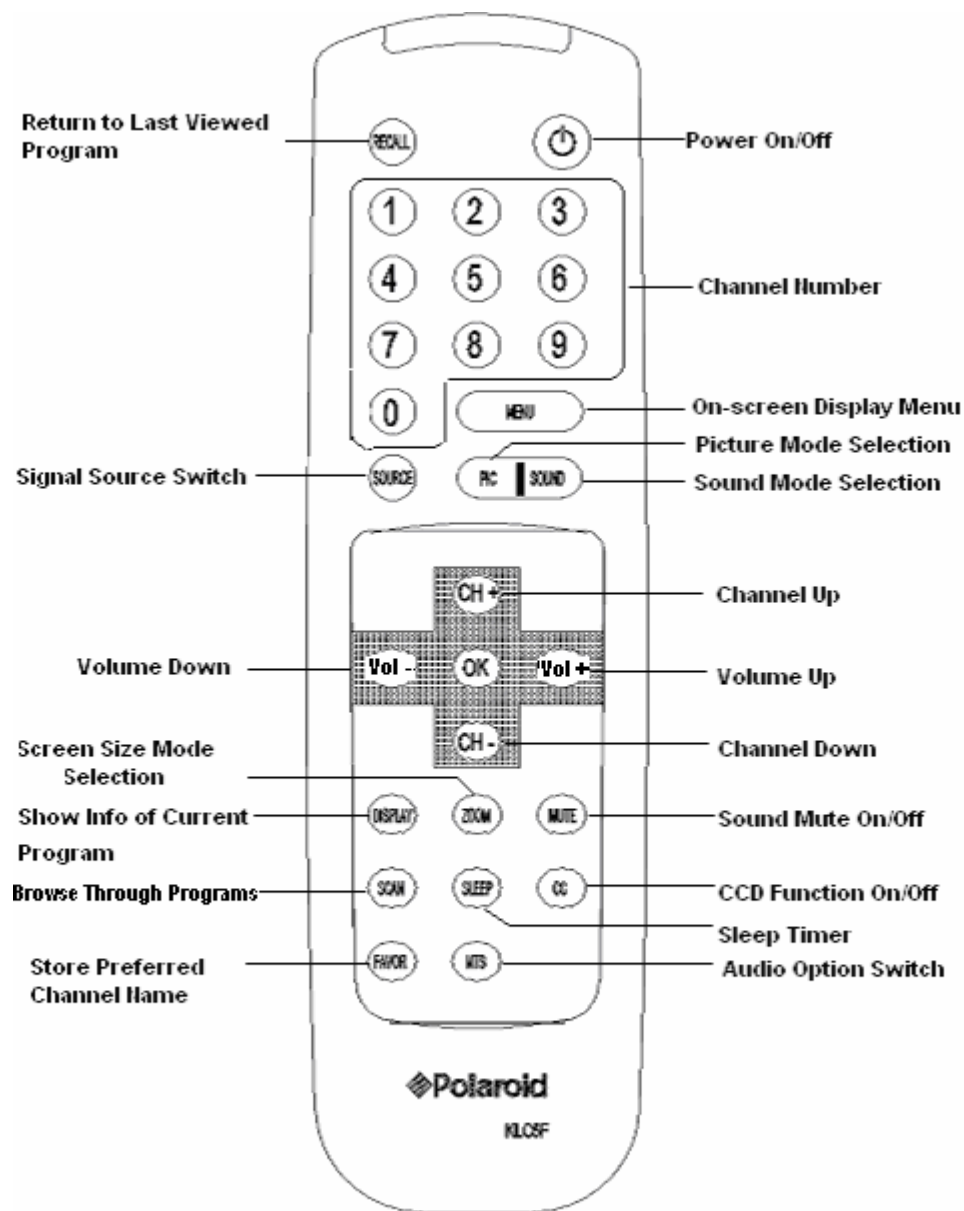

Note:

1. When in operation, point the remote control directly at the infrared sensor.
2. Do not subject the remote control to impacts, water or disassembly.
3. When pressing the buttons on the remote control, allow an interval of no less than one second between selections.

INSTALLATION

1. Remove the LCD TV from the box and place it on a flat surface in a well-ventilated location.
2. Connect the output terminal of RF cable to the corresponding TV RF signal input terminal. The LCD TV is a high technology digital product, use quality RF cables to obtain optimal results.
3. Connect the output terminal of the AV devices such as DVD player, VCR, etc. to the corresponding terminal of your LCD TV.
4. Connect one end of the D-sub terminal to the corresponding terminal of the host computer, and connect the other end to the corresponding LCD TV terminal. Screw down the screws on both sides to secure it.

Caution:

When connecting, plug directly and lightly to the interface, otherwise you may damage the pins in the connector.

5. Ensure that every AV signal cord is correctly connected to the corresponding jack.
6. Put the DC power plug in the DC input outlet of the TV, then plug the AC power plug of the power adapter in the AC power outlet.
7. The panel can be tilted upwards **up to 10°** to achieve better viewing angle. When doing so, rotate the TV with two hands, one to hold the pedestal, the other to tilt the panel. **Take care to do this with moderate pressure to prevent damage to the TV.**

GENERAL OPERATION

To Turn the TV On

After the power cord is plugged into the power socket, the TV will enter Standby mode.

Press  on the remote control or the front panel to turn the TV on

To Turn the TV Off

1. Press  on the remote control or the front panel to turn the TV off.
2. Unplug the DC power adapter from the AC wall outlet and then unplug the power adapter from the TV to turn the set off completely.

Caution: The TV will be shut off automatically when AC power is interrupted. Unplug the power adapter from the AC outlet if this happens. The last used TV mode will appear when power resumes.

Do not turn the TV on/off too often.

Unplug the power adapter from the AC outlet if power is suddenly interrupted.

FUNCTION INTRODUCTION

MENU OPERATION

1. Use the On Screen Display menu to set and adjust functions
2. Use CH+/CH- to select the desired menu after pressing MENU, then press Vol+/OK to enter the next submenu; Use Vol+/Vol- to select the menu options and return to the previous menu by pressing MENU again. The menu will disappear without any operation within 10 seconds.

In TV, AV, S-VIDEO, YPbPr and PC modes

Picture

- Brightness
To adjust the picture's brightness
- Contrast
To adjust the picture's contrast
- Sharpness
To adjust the picture's definition
- Colour
To adjust the picture's color
- Tint
To adjust the picture's tint. (For NTSC signal only)

Note: Picture menu options in other signal sources:

AV, S-VIDEO: the same as in TV mode

YPbPr, PC: Brightness and Contrast only

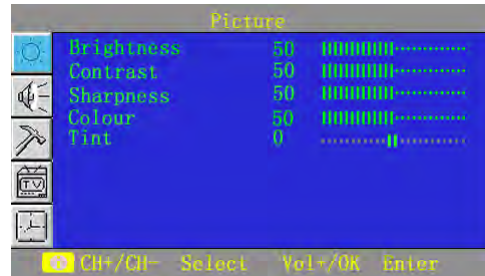

Sound

- Volume
To increase or decrease the volume
- Balance
To balance the volume between the left and right speakers
- Woofer
To turn on/off the woofer
- Spatial
To turn on/off the surround sound
- Equalizer (submenu)
Use OK/Vol+ to enter the Equalizer submenu, you can increase or decrease the value of the sound output in different frequency ranges

Note: The Sound menu options are the same in TV signal mode as well as in other signal source modes

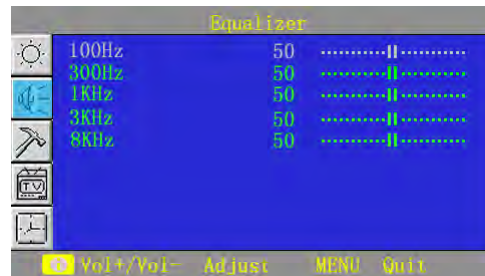
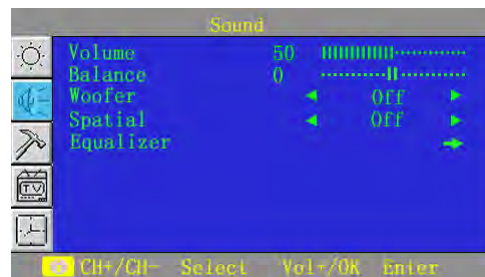

Setup

- Language

To select the displayed language

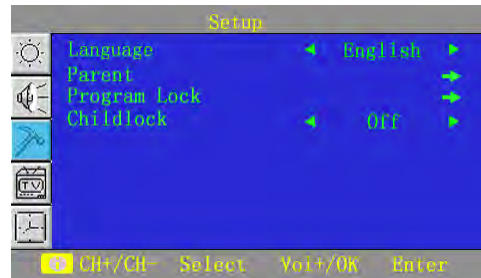

- Parental Lock

In the Parent submenu, first the Access Code menu appears. When you switch to a locked channel, you will see this menu:

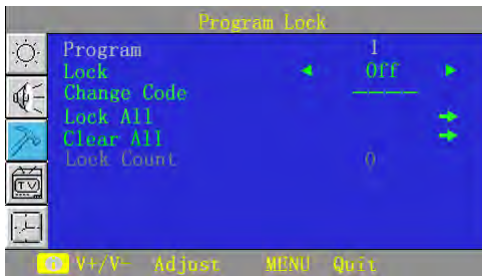

In the Parent menu two options of TV Rating and MPAA Rating appear on display:

TV Rating: Used to block some programs (eroticism, violence). Navigate to the desired Rating (FV, D, L, S, V) using the CH+/CH- buttons on your remote. Use VOL +/- buttons on your remote to select the desired rating. "U" indicates Unblocked, and "B" indicates Blocked. To save the value press OK. To return to the previous menu, press MENU.



See picture at right:

MPAA Rating: Used to block some programs (eroticism, violence). Navigate to the desired rating (G, PG, PG-13, R, NC-17, X) using the CH+/CH- buttons on your remote. Use VOL +/- buttons on your remote to select the desired rating. "U" indicates Unblocked, and "B" indicates Blocked. To save the value press OK. To return to the previous menu, press MENU.

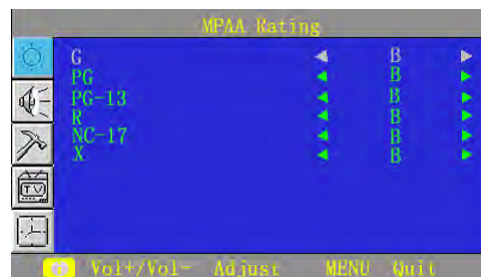

See picture at right:

Note: After a rating level has been set to B (Blocked) in TV RATING and MPAA RATING, the TV blocks other TV programs that contain content equal to or greater than the rating.

Program Lock

Input the default password of 1235, the submenu of Parent will display if the password is correct.

(a) When changing the password, the changed password will be updated after four digits are input. The word “ok” appears after you input the same number twice, if the two passwords are different the word “Failure” will appear.

(b) When All Clear is selected, all programs are unlocked.

(c) After you exit from the Program Lock menu and switch to a locked channel, the picture and sound will be locked unless you input the correct password. The channel will remain unlocked until the TV is turned off. After the TV is turned on again, the password must be re-entered to view the locked channels again.

(d) If your program is locked, input the correct password to enter the Auto Search submenu. Operating Auto Search will cancel the locked status.

(e) The default password is always effective.

(f) Entering the default password allows you to go to the Program Lock menu, then change the password while the default password is still effective. This branch menu cannot be entered if a wrong password is keyed in, In this case, press MENU to return to the previous menu.

(g) There will be slight delays while using the Lock All and Clear All functions.



- Child Lock

In Child Lock On mode, the buttons on the TV do not work. A prompt “Panel buttons are being locked” will be displayed. However, the remote control buttons will still function. When the TV is on and the Child Lock is on, a prompt “Locked, power off after 6s” will appear. Use the remote control to control the TV. Otherwise, the TV will automatically enter into Standby mode.

Tune

Press CH+/CH- to enter the Tune menu from the main menu. There items for adjustment are:

Program, Add/Erase, Antenna, Auto Search and Name.

- Program

To save current program number.

- Add/Erase

To erase or add the channel.

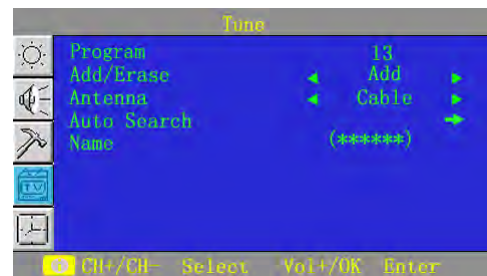

- Antenna

To display the RF antenna mode, when this mode is Air, Auto Search begins searching from channel 2 to channel 69. When this mode is Cable, Auto Search begins from channel 1 to channel 125. After searching, all available channels are stored in the TV's memory,

- Auto search

Auto Search will stop in three situations:

1. The TV does auto search and stores channels from VHF/UHF automatically.
2. All 68 channels (Air mode) or 125 channels (Cable mode) are occupied
3. You can manually stop the search process by pressing Vol+/Vol-.

In the above 3 situations, the search will stop automatically and the TV will return to the first channel. In situation 3, the TV will also return to the Tune menu.

- Name

To name channels, press Vol+/Vol- to select the input character position while using four number buttons on the remote control to enter characters: 1: Capital English; 2: Arabic numbers (0-9); 3: Special characters such as "#"; 4: Resuming "*" in unnamed status.

Note: There is a PC Setup menu for the Tune menu in PC signal source; there is no Tune menu in AVS, Video, or YPbPr signal source.

Clock

- Clock

The current time can be input by pressing the number buttons (0-9) and Vol+/Vol-.

- Antenna

To display RF antenna mode.

- Time/ Off Time

The function of Time/Off Time is only active when

Time/Off Time is on. Press the number buttons and Vol+/Vol- to adjust the time.

Press CH+/CH- to select the options in Clock mode: Time, Channel, and Off Time. Press Vol+/Vol- to set the corresponding value.

1. Whenever the main power is turned off and back on, the clock displays "12:00AM". Use Vol+/Vol- to switch between AM and PM and use numeric buttons to set the time.

2. Use Vol+/Vol- to set times in the On Mode between Off, Once and Always. Off indicates this function is not available. Once indicates one time only operation for the On Mode.

Always indicates mode will be turned off afterwards automatically.

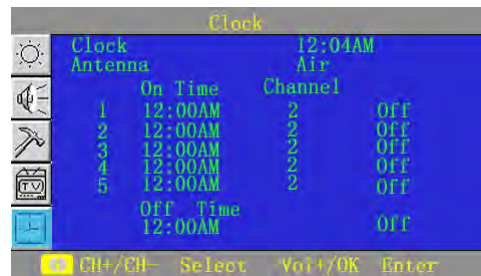

3. This function is only available when the main power supply is connected.

4. For the ClockTime and Off Time, “Minute” ranges from 00 to 59 and “Hour” ranges from 1 to 12 AM and 1 to 12 PM. When “Hour” turns to “--” “Minute” also turns to “--” and the Clock function stops.

- Channel

Select the On Program channel from 2 to 69 (Air mode) or from 1 to 125 (Cable mode) by pressing Vol+/Vol- repeatedly or numeric buttons directly. Select the items by pressing CH+/CH-.

1. When TV is on, it turns directly to the preset channel at the preset TIME. When TV is in standby mode, at the preset time it first turns on and then goes to the preset channel.

2. There will be no operation of the preset program during Auto Search and Always modes.

3. If On Mode is in Once mode, this function is turned Off automatically.

4. When the TV is on and the values of On Time and Off Time are the same, only Off Time is valid. After the Once operation is done, this function is turned Off automatically. Always remains active. When the TV is off, if the values of On Time and Off Time are the same, only On Time is valid.

5. When the TV is restarted after disconnecting the AC power, all settings are lost and must be reset. If the TV is turned off using the remote control, all settings are saved.

Note: The TV can be turned on automatically only while it is in standby mode. The Clock menu functions in other signal sources the same as it does in TV mode.

PC Setup

- H Position

To adjust picture horizontally

- V Position

To adjust picture vertically

- Clock

To adjust the picture's sampling clock

- Phase

To adjust pictures' sampling phase

- Colour Temp

Four modes of Warm, Normal, Cool and User to choose from with Vol+/Vol-. In User mode, adjustments can be made to three options: User Red, User Green and User Blue.

- Auto Adjust

To adjust the picture's clock phase and color temperature to the appropriate value

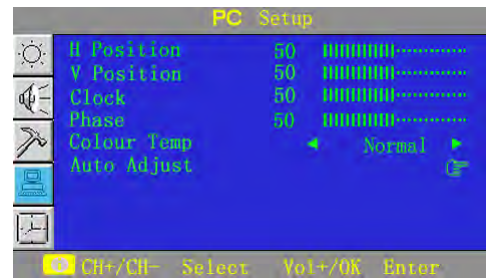

Note: The PC Setup menu is only available for the PC signal source.

OTHER FUNCTIONS .

• Volume Control

1. Press Vol+/Vol- to increase or decrease the volume when no menu is displayed on the screen. The Volume menu will turn off automatically if there is no operation in about 5 seconds.

2. Press MUTE on the remote control to turn MUTE mode off and on. In Mute mode, "MUTE" in red letters will appear on the upper-right corner of the screen. This sign is hidden when menu operation is entered, but MUTE still operates. The sign appears again when menu operation is exited. When there is no valid signal input, the TV will be mute (but no mute sign will show).

3. MTS

- The TV will identify MTS in channels automatically. The TV memorizes SAP after it is auto identified. The TV memorizes Stereo after it is auto identified.
- There is an OSD menu to show the changes in broadcasting signals.
- Press MTS to switch between Mono, Stereo and SAP:

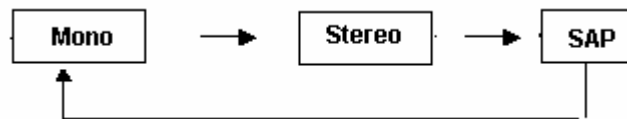

4. Sound Mode Selection

Press SOUND to select Personal, News, Theater and Music modes and activate the Picture Mode for User setting. The Personal mode allows you to customize the options of the Sound Menu in any input mode. The last three modes are default settings and cannot be adjusted.

Sound Mode	Sound Quality
Personal	For the user's preference
News	For general programs of conversation and news reports
Theater	For better audience sound for movies
Music	For general music programs

Note: The Volume Control works the same in all signal sources.

• Picture Mode Selection

Press PIC to Switch among Personal, Soft, Normal and Rich modes.

Picture Mode	Picture Quality
Personal	For the user's preference
Soft	For more mellow pictures
Normal	For general programs
Rich	For better visual effects in movies

Note: The setting of this selection works the same in all signal sources.

- **CCD**

Press CC to see the menu on the right. Select the desired option among CC1-CC4, T1-T4 and OFF with CH+/CH-. Confirm your choice by pressing OK.

- **Favorites**

Press FAVOR to see the menu on the right:

1. Mode including Auto and Manual. They are respectively stored in Air or Cable mode
2. In Auto mode, the TV stores the channel name (if any has been programmed) to Favorite Channels. It will save the latest five available channel names.
3. In Manual mode select different sorting options with CH+/CH-.

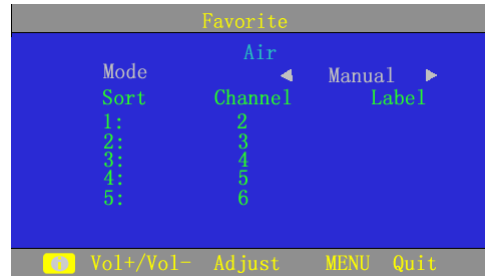

In Auto mode Vol+/Vol- are invalid while CH+/CH- and OK still function.

- **Recall**

In TV mode, press RECALL on the remote control to view the previous channel.

In other signal sources, press RECALL on the remote control to view the previous signal source.

- **Input Signal Switch**

Press SOURCE on the remote control to display the source menu and select the signal source. Options are TV, AV, S-VIDEO, YPbPr and PC. Press CH+/CH- to select the different signal source; Press Vol+ or OK to enter into the selected signal source. Press SOURCE again to close the source menu.

- **Channel Changing**

Use the number buttons to choose the desired channel directly or press CH+/CH- on the panel or remote control to increase/decrease the channel number. If a channel number is in Skip On mode, the next available channel will display.

A maximum of 3 digits can be keyed in at one time with the number buttons on the remote control. The first input number is for hundreds, if it is "1", "1-" appears on. The TV will switch to channel 1 if no more numbers are input within 3 seconds. The second is for tens if it is "2", "12-" appears on screen. The TV will switch to channel 12 if no more numbers are input in 3 seconds. The third is for ones. Press OK to turn to the desired channel quickly after the corresponding number is input.

Note: This function is only available in TV mode

- **Sleep Function**

Press SLEEP on the remote control once to activate the function and additional times to select a sleep time of 0, 15, 30, 45, 60, 90, 120, 150, 180, 240 and 0 minutes. This will be reflected at the top right corner of the screen. After this step is done, press SLEEP to view the set sleep. See the illustration at the right.

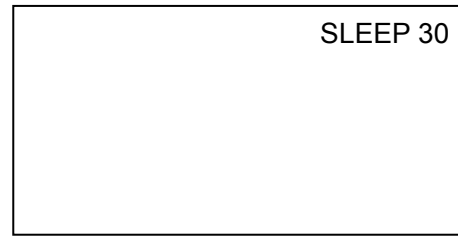



- **Indicator Lights in Sleep Mode**

Status	Light Color	Description
On/Off	Green/off	The TV works normally; powers off
Standby	Red	The TV is in Standby Mode
Timer On/Off Or Sleep	Yellow	Timer On/Off is valid or Sleep is on
Sleep (PC)	Red	Sleeps for power-saving; Activates again as PC sends a signal or any button on the remote control is pressed
Receive the signal from the remote control	Flickering	The indicator is flickering when the TV receives signal from the remote control

•TROUBLESHOOTING

Before calling our customer care number, please check the following table to see if the below mentioned symptoms can be diagnosed and fixed.

Symptoms	Possible Reasons	Correction
No picture, no sound, and no indicator light on	1.The power adapter is not plugged in 2.The power is off	1.Plug the power adapter in 2.Turn the power on
No picture, no sound, but the green light indicator	Functions of On/Off Time and Sleep have been set	Press  to turn on the TV
No picture, no sound, but the yellow light indicator	1.PC is in D-sub Mode without any PC signal input 2.The signal cable is not connected correctly	1.Press  or input the PC signal 2.Connect the signal cable properly
Picture and sound are abnormal	1.Contrast, sharpness, and color are set improperly 2.Color system is set improperly 3.Sound system is set improperly	1.Adjust the value of Contrast, sharpness, and color 2.Set the Color system to the country broadcasting standard 3.Set the Sound system to the country broadcasting standard
Picture is spotted or has "snow"	Signal source is low-grade; The signal is in a lower quality; No signal input	Use a high quality signal cable; Connect an input signal
Blue background in AV mode	No Video signal or the signal cord is improperly/not connected	Connect the signal cord properly
Picture is unclear, or moves or has horizontal black stripes in PC mode	Picture is not well adjusted	Adjust automatically by selecting Auto Adjust or adjust Clock Phase, H Position and V Position manually in the PC Setup menu
PC Picture is not in the middle of the screen	Picture is not well adjusted	Adjust picture automatically by resetting H Position, V Position, Phase and Clock
No sound	No Audio signal or the signal cord is improperly/not connected	1.Connect the audio signal cord properly 2.Set the sound system properly
The remote control does not work	Batteries are improperly installed or exhausted	1. Check the positive and the negative battery polarities 2. Check if the batteries are loose 3.Replace the batteries

SPECIFICATIONS

Items		Specifications
LCD panel items	Size (diagonal)	15.0 inch
	Brightness: 250 cd/m ²	
	Contrast: 400:1	
	Angle of View: 120 ⁰ (H)/100 ⁰ (V)	
	Speed Response: 16 ms	
	Lamp Life: 50,000 Hours	
	Recommended	1024 X 768
	Pixel Pitch	0.297mm(H) X 0.297mm (V)
	Number of Dots	1024XRGBX768
	Viewable Area	304.1mm(H) x 228.1mm (V)
	Color Display	16.7million
Color System	NTSC	
Sound System	M	
PC Qualified Input Format	VGA/SVGA/XGA	
YPbPr Input Format	480i, 480P, 576i, 576P, 720P, 1080i, 1080P (50/60Hz)	
Audio Output Consumption	2x2.0 W	
AV-Audio Input	One way (S-Video is using in community)	
AV-Video Input	One way	
Headphone Output	One way	
Comb Filter	YES	
S-Video Input	One way	
YPbPr Input	One way (with audio input)	
D-sub Video Input	One way	
D-sub Audio Input	One way	
DC Voltage Input	DC 12V	
Power Adaptor Voltage Input	Please refer to the back panel of the unit.	
Rated Power Consumption		
Standby Power Consumption	≤1.5W(with power adapter)	
Unit Dimension	454mm(W)×343mm(H)×166mm(D)	
Net Weight	4.5kg (approximate)	

Note:

The LCD panel is a high technology product that reproduces finely detailed pictures. Occasionally, a few non-active pixels may appear on the screen as a fixed point of blue, green, red, black or white. Please note that this does not affect the performance of your LCD TV.

For service, support and warranty information, visit www.polaroid.com or in the US call 1-866-289-5168, in Canada call 1-866-301-7922 and in Mexico call 01-800-400-2443.

"Polaroid" and "Polaroid and Pixel" are trademarks of Polaroid Corporation, Waltham, MA, USA.

