

15" LCD
FLU-1514SA



20060928

Table Of Contents

Important Safety Instructions -----	2
Product Features -----	4
Front Panel -----	5
Rear Panel -----	6
Remote Control -----	7
System Connections -----	9
Connecting to External AV Signal Source-----	9
Connecting to External AV Signal Source (COMPONENT)-----	10
Connecting to PC -----	11
Connecting to Power Cable-----	12
Connecting to TV Signal -----	13
TV Functions -----	14
Preparations-----	14
Image Setting-----	14
Audio Setting-----	16
Timer Setting-----	17
Setup Setting-----	17
NICAM Function -----	21
Other Functions -----	22
External AV Input Function-----	22
Computer Screen Function-----	22
Troubleshooting -----	23
Specifications -----	24

Important Safety Instructions

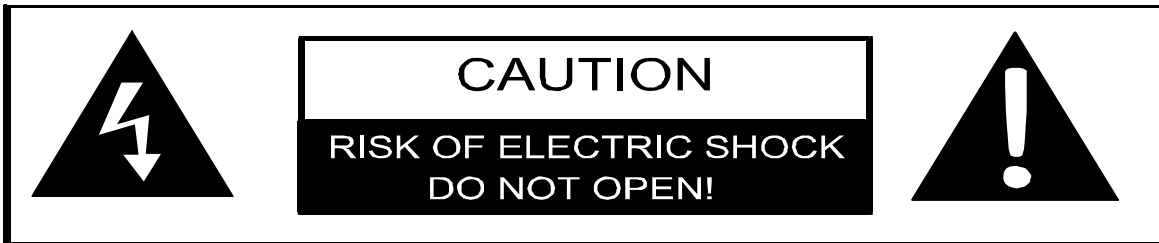

The lightning flash with arrowhead symbol, within an equilateral triangle, is intended to alert the user to the presence of un-insulated “dangerous voltage” within the product’s enclosure that may be of sufficient magnitude to constitute a risk of electric to persons.



The exclamation point within an equilateral triangle is intended to alert the user to the presence of important operating and maintenance (servicing) instructions in the literature accompanying the appliance.

CAUTION

1. In order to ensure the safety of the product, do not remove any cover and attempt to repair the unit. If any service is needed, please contact the distributor or its authorized service center.
2. To reduce the risk of electric shock, do not remove the cover (or back). No user-serviceable parts inside. Refer servicing to qualified service personnel. Unplug the product from the wall outlet before servicing or when it is unused for a long period of time.
3. The manufacturer should not hold responsibility for the damage caused by any substitutions and modifications of the product without authorization from the manufacturer or authorized unit.

WARNING

The apparatus should not be exposed to dripping, splashing or any liquid. No objects filled with liquids, such as vases, should be placed on the apparatus.

Important Safety Instructions

NOTES

1. Read these instructions.
2. Keep these instructions.
3. Heed all warnings.
4. Follow all instructions.
5. Do not use this apparatus near water.
6. Clean only with dry cloth.
7. Do not block any ventilation openings. Maintain well ventilated conditions around the product. Do not put product on bed, sofa or anything that blocks ventilation. Install according to the manufacturer's instructions.
8. Do not install near any heat sources such as radiators, heat registers, stoves or other apparatus (including amplifiers) that produce heat.
9. Read, heed and follow all instructions to ensure correct and safe installation and interconnection of the apparatus;
10. The apparatus shall not be exposed to dripping or splashing and that no objects filled with liquids, such as vases, shall be placed on the apparatus;
11. The mains socket-outlet shall be installed near the apparatus and the mains plug shall remain readily operable;
12. Protect the power cord from being walked on or pinched particularly at plugs, convenience receptacles, and the point where they exit from the apparatus.
13. Only use attachments/accessories specified by the manufacturer.
14. Use only with the cart, stand, tripod, bracket, or table specified by the manufacturer, or sold with the apparatus. When a cart is used, use caution when moving the cart/apparatus combination to avoid injury from tip-over.
15. Unplug the apparatus during lightning storms or when unused for long periods of time.
16. Refer all servicing to qualified service personnel. Servicing is required when the apparatus has been damaged in any way, such as power-supply cord or plug is damaged, liquid has been spilled or objects have fallen into the apparatus, the apparatus has been exposed to rain or moisture, does not operate normally, or has been dropped.

Note: Do not touch the color TFT LCD screen by hand directly.

Copyright Protection

This product incorporates copyright protection technology that is protected by U.S. patents and other intellectual property rights. Use of this copyright protection technology must be authorized by Macrovision, and is intended for home and other limited viewing uses only unless otherwise authorized by Macrovision. Reverse engineering or disassembly is prohibited.

Product Features

This product incorporates an LCD display and TV receiver in one system.

Multiple Mode

TV mode

COMPOSITE mode

S-VIDEO mode

COMPONENT mode

VGA mode

High Quality Property

LCD (Liquid Crystal Display)

Designed with 15" color TFT liquid crystal display that shows a clear, crisp image.

Stereo amplifier

Built-in stereo speakers (3 watts x 2) provide high quality sound.

AV and VGA Input

Can be connected to external audio/video signal sources and a PC.

Special Function

Supports the sleep time setting function.

Multi-audio and Multi-video modes

Supports multi-audio and multi-video modes, which provides more selection.

Auto TV Searching Function

Can be connected to the TV antenna, supports Auto TV programs searching function.

NICAM Function

Supports the NICAM function. According to the broadcasting programs, you can choose the corresponding soundtrack.

NOTE: It is normal for a TFT screen to experience some light or dark spots appearing on the LCD screen.

Front Panel

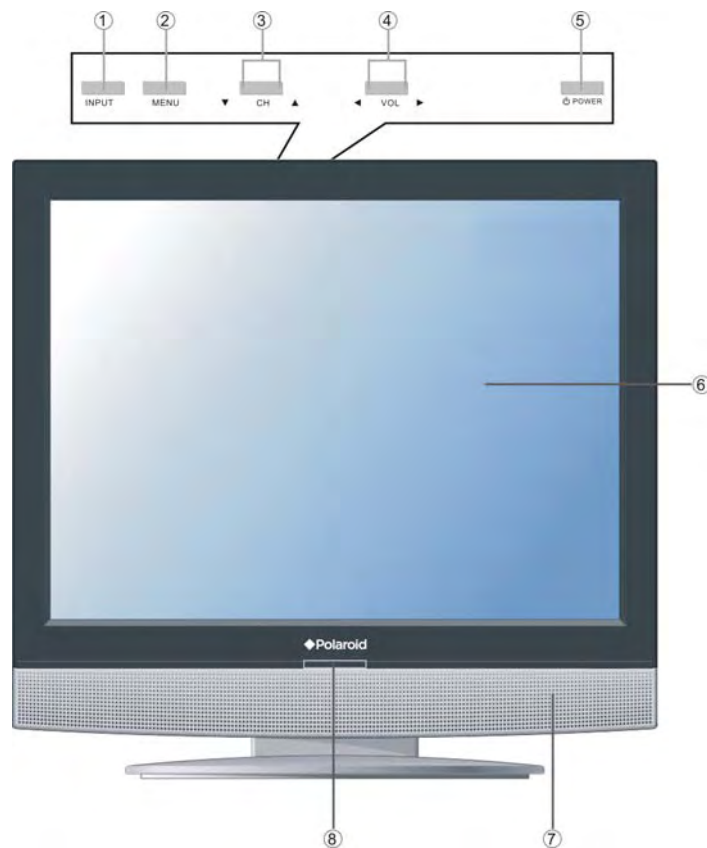

- 1. INPUT button**
Press to select the modes: TV, COMPOSITE, S-VIDEO, COMPONENT or VGA.
- 2. MENU button**
Press to enter or exit setup menu.
- 3. CH▼/▲ button**
In TV mode, press to select channels.
In setup menu, the same function as ▼/▲ direction buttons.
- 4. VOL◀/▶ button**
In TV mode, press to decrease or increase the volume.
In setup menu, the same function as ◀/▶ direction buttons.
- 5. POWER button**
Press to enter or exit the standby mode.
- 6. 15" color TFT screen**
15" color TFT screen clearly show the data.
- 7. Speaker**
Outputs high quality stereo sound.
- 8. Remote Sensor**
Remote sensor window for the remote control.

Rear Panel

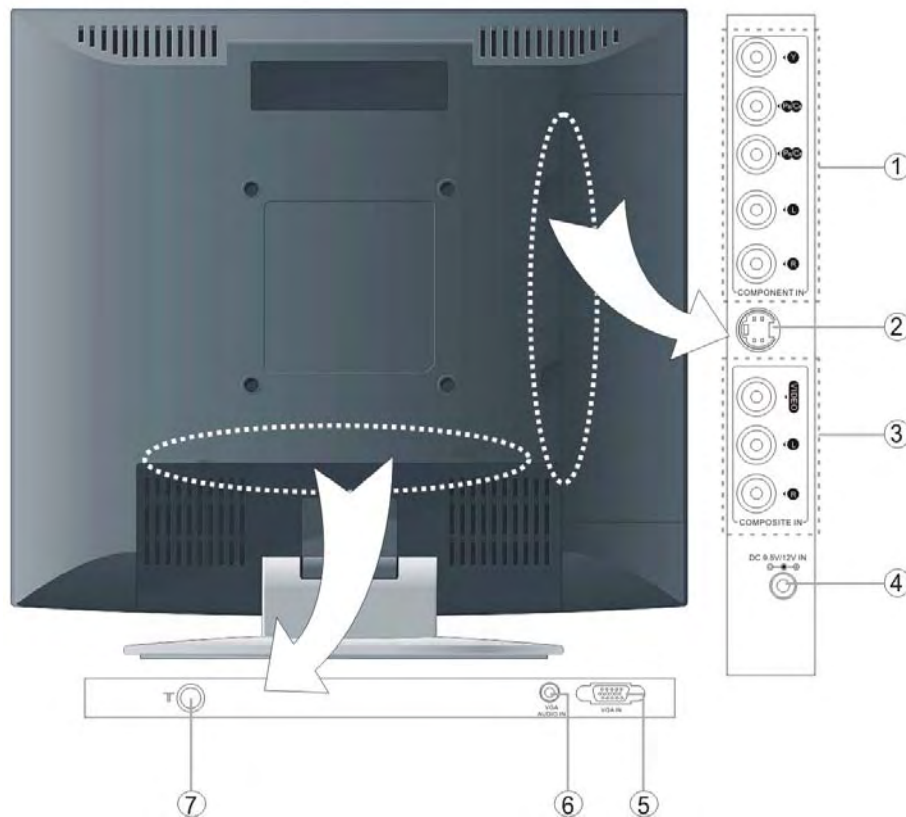

1. Component (YPbPr) Input Jacks

Connect to the COMPONENT input and the L/R audio inputs in COMPONENT mode.

2. S-VIDEO Input Jack

Connect to the S-VIDEO input in S-VIDEO mode

3. VIDEO/L/R Audio Input Jack

Connect to the VIDEO input in COMPOSITE or S-VIDEO mode.
Connect to the L/R audio input in COMPOSITE or S-VIDEO mode.

4. DC 9.5V/12V In Jack

Connect to power adapter.

5. VGA Input Jack

Connect to the VGA output jack on a personal computer.

6. PC AUDIO Input Jack

Connect to the PC audio output jack.

7. TV Signal Input Jack

Connect for the external TV signal input.

Remote Control

Remote Control Drawing

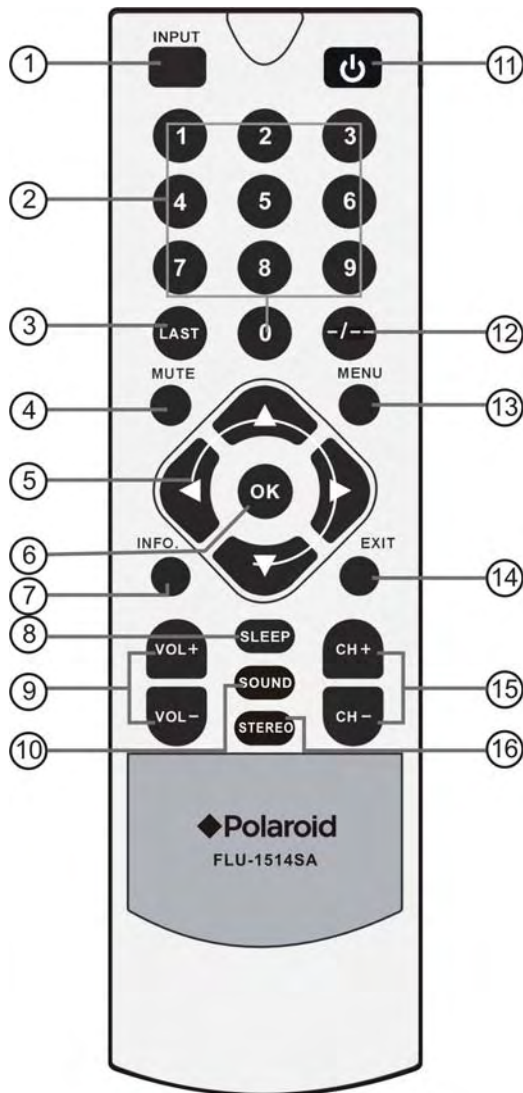

- 1. INPUT Button**
Press to select the modes: TV, COMPONENT, VGA, COMPOSITE or S-VIDEO.
- 2. 0~9 Number Buttons** Press to select numbers.
- 3. LAST Button**
In the TV mode, press to return to the channel last viewed.
- 4. MUTE Button**
Press to turn on or off the speaker output.
- 5. Direction Buttons (▲▼◀▶)**
In the setup menu, press the ▲▼ button to select the desired items, press the ◀▶ button to adjust or set.
- 6. OK Button**
Press to confirm selection in the menu.
- 7. INFO. Button**
Press to display the reference information.
- 8. SLEEP Button**
Press to select sleep time.
- 9. VOL +/- Button**
Press to increase or decrease the volume.
- 10. SOUND Button**
Press to shift sound mode among USER, STANDARD, MUSIC, MOVIE, SPEECH.
- 11. POWER Button**
Press to enter or exit the standby mode.
- 12. -/-- Button**
In TV mode, press this button to select a one-digit or two-digit channel number and then press the number buttons to select the desired channel.
- 13. MENU Button**
Press to enter or exit the setup menu.
- 14. EXIT Button**
Press to exit from the setup menu.
- 15. CH +/- Button**
In TV mode, press them to select channels.
- 16. STEREO Button**
Press to shift sound track when in TV mode.

Remote Control

Prepare the Remote Control

Gently push the back cover to open the battery compartment.

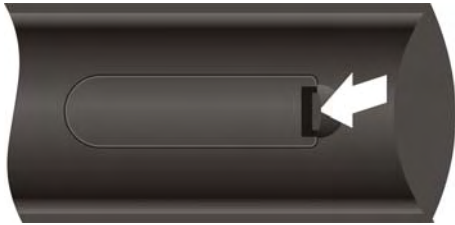

Insert two batteries (1.5V, size AAA) into the compartment; please make sure the polarity matches the symbols on the inside the compartment.

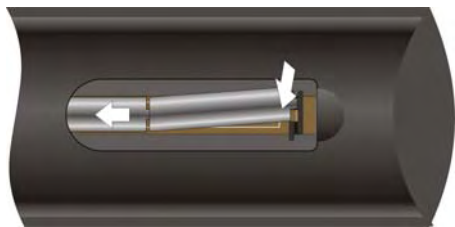

Gently push the back cover into place to close it.



- Under normal use, the battery should last for about six months.
- Remove the battery when the remote is not in use for a long time.

Using of Remote control

Point the remote control no more than about 7m from the remote control sensor and within about 60 degrees of the front of the unit.



- The operating distance may vary depending on the brightness of the room.

Notes:

- Do not point bright lights directly at the remote control sensor.
- Do not place objects between the remote control and the remote control sensor.
- Do not use this remote control while simultaneously operating the remote control of any other equipment.

System Connections

- Do not connect the power cord until all other connections have been made.
- Remove the jack cover before making any connections.
- Make sure you observe the color cord when connecting audio and video cables.

Connecting to External AV Signal Source

Use the audio and video cables to connect to the AV input jacks on the rear panel of the unit and to the external AV signal source. Use the S-VIDEO cable to connect the S-VIDEO input jack on the rear panel of the unit to the external AV signal source.

After connection, turn on the power of the unit and the external AV signal source and then press the INPUT button to shift to COMPOSITE or S-VIDEO mode.

Note: The L/R audio input jacks can be used in the both COMPOSITE and S-VIDEO modes.

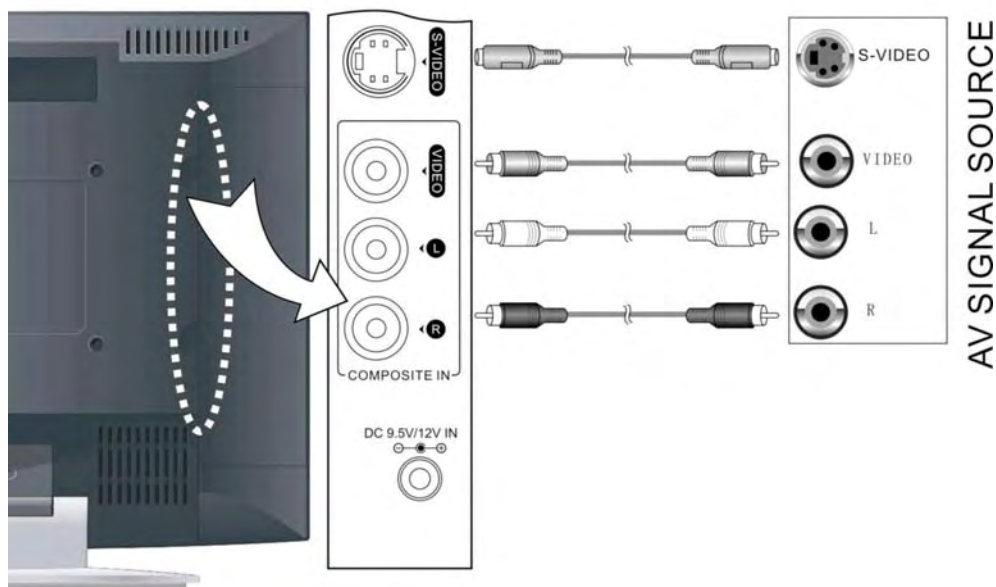

System Connections

Connecting to External AV Signal Source (COMPONENT)

Use the audio and video cables to connect the Component input jacks on the rear panel of the unit to the external AV signal source.

After connection, turn on the power of the unit and external AV signal source and then press the INPUT button to shift to COMPONENT mode.

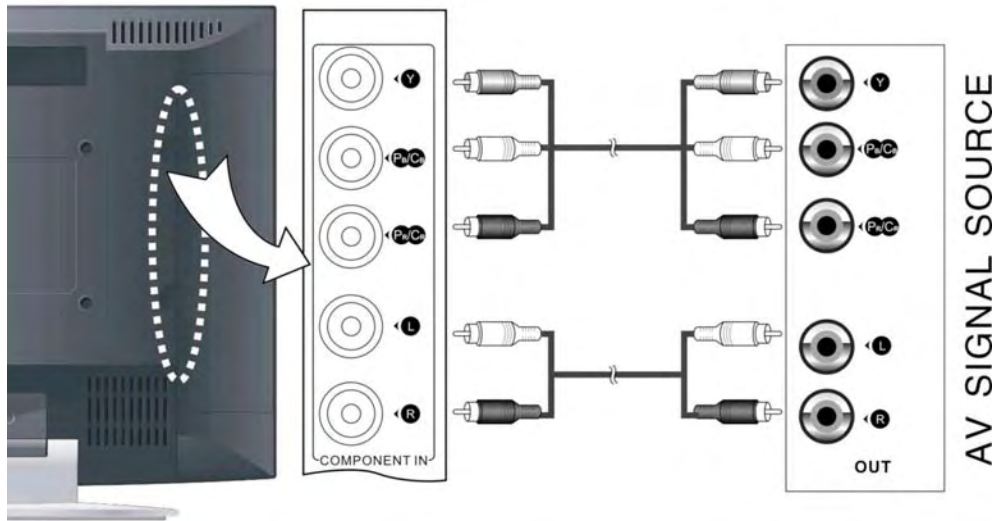

System Connections

Connecting to PC

The unit can be connected to PC (person computer) via the VGA cable. Follow the steps and the figure below to connect:

1. Connect one end of the VGA cable to the VGA input jack on the rear panel of the unit.
2. Connect the other end to the PC.
3. Connect one end of the audio cable to the PC audio input jack on the rear panel of the unit.
4. Connect the other end to the PC audio output jack.
5. Please set the PC's resolution at 1024x768@60Hz

After connection, turn on the unit and the PC and then press the INPUT button to shift to VGA mode.

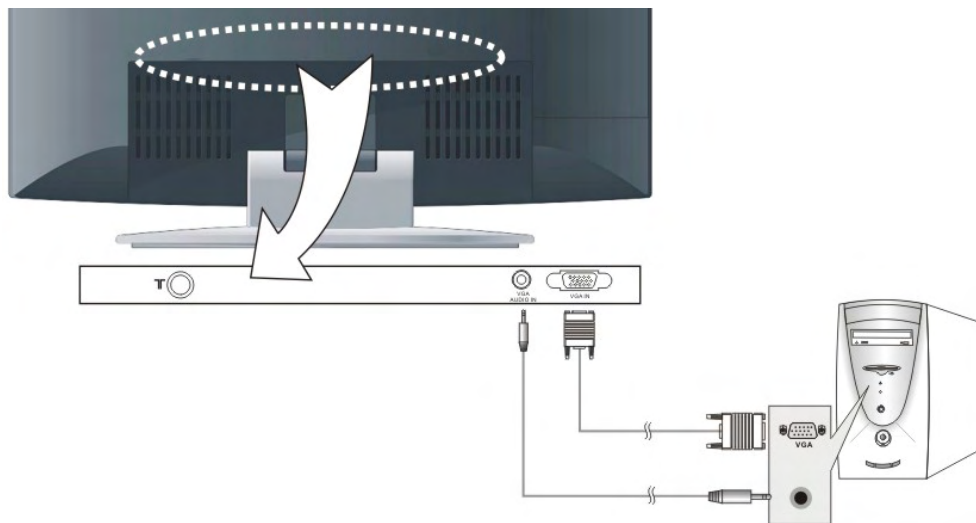

System Connections

Connecting to Power Cable

Plug the two-prong end of the power cord to an AC100-240V outlet. If you have difficulty inserting the plug, turn it over and reinsert it. If the unit will not be used for a long time, disconnect the plug from the outlet.

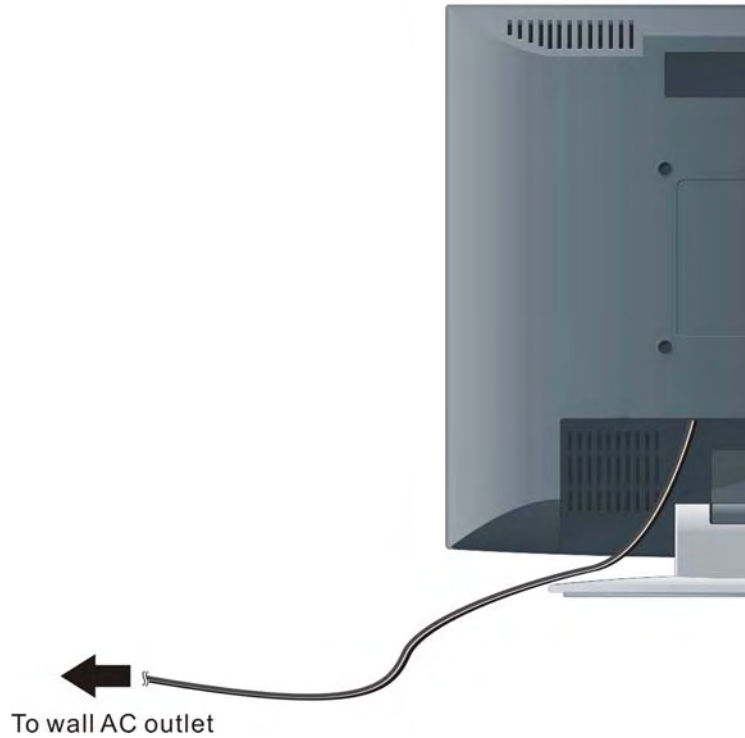

System Connections

Connecting to TV Signal

This unit can be connected to the TV signal input source via the TV jack on the rear panel. After connection, turn on the power of the unit; press the INPUT button to shift to TV mode.

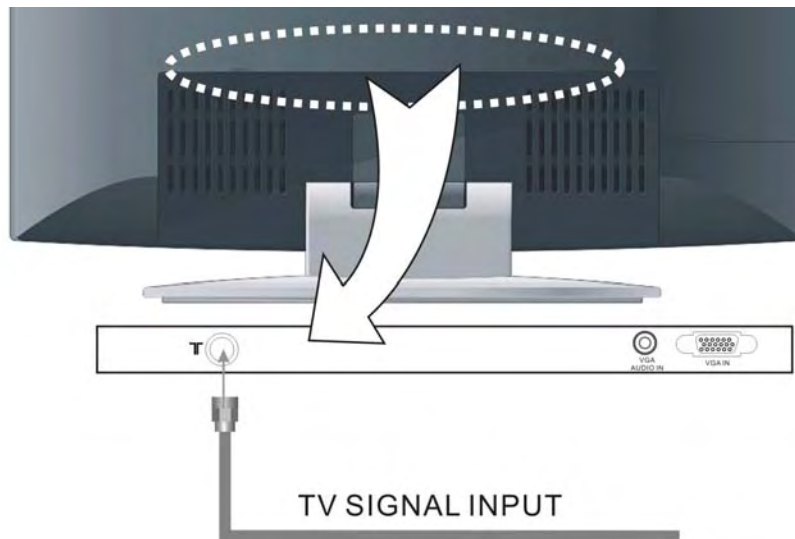

After connecting to the antenna, turn on the unit, and go on with program searching, you can follow the below steps to select channels:

1. For 0~9 channel:
Press the number buttons to select the channel X, it will go to the selected channel immediately.
2. For 10~99 channel:
Press the number buttons to select channel XX, and it will go to the selected channel immediately.

* X is the channel number.

TV Function

Preparations

1. After connection, press the POWER button to turn on the power.
2. Press the INPUT button to shift to TV mode. You can go on with the following operations:

Image Setting

Note: This item is only available when there is a signal input.

Press the MENU button once to enter the setup menu, as shown on the right:

In the setup menu, press the ▲▼ button to select **Image** and then press the OK button to enter the item. Press the ▲▼ button to select. Press the MENU button to return to the previous menu.



Scheme Setup

Press the ▲▼ button to select **Scheme** and press the OK button to enter. Press the ▲▼ button to select the desired item and press the OK button to confirm your selection. Press the MENU button to return to the previous menu.

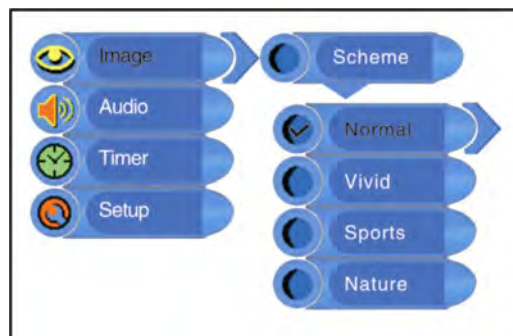

Picture Setup

Press the ▲▼ button to select **Picture** and press the OK button to enter. Press the ▲▼ button to select the desired item and press the OK button to confirm your selection. Press the MENU button to return to the previous menu.

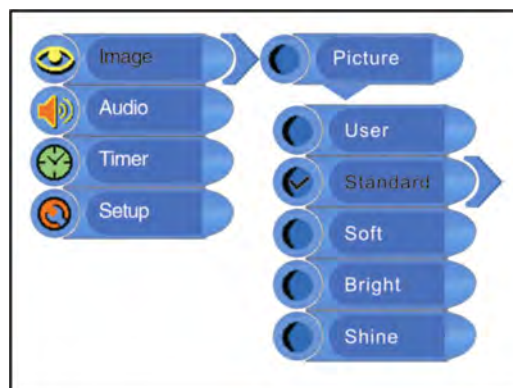

TV Function

Brightness Setup

Press the ▲▼ button to select **Brightness** and press the ◀▶ button to adjust the value. Press the MENU button to return to the previous menu.

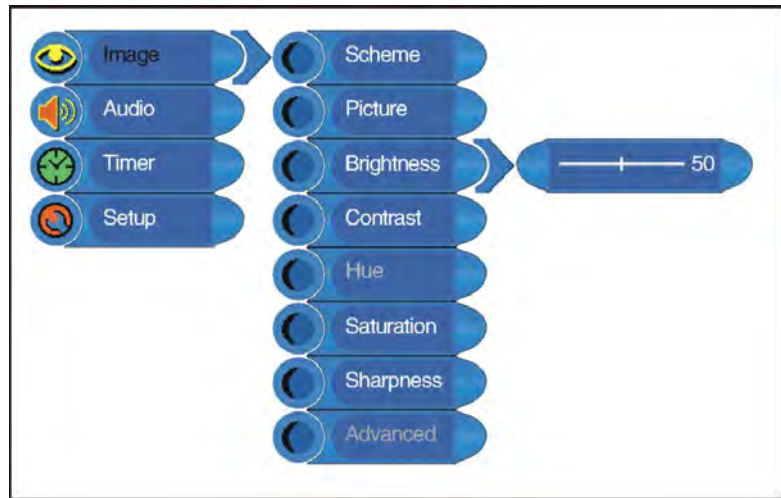

Contrast Setup

Press the ▲▼ button to select **Contrast** and press the ◀▶ button to adjust the value. Press the MENU button to return to the previous menu.

Hue Setup

Press the ▲▼ button to select **Hue** and press the ◀▶ button to adjust the value. Press the MENU button to return to the previous menu.

NOTE: This feature is only available under NTSC TV signal mode.

Saturation Setup

Press the ▲▼ button to select **Saturation** and press the ◀▶ button to adjust the value. Press the MENU button to return to the previous menu.

Sharpness Setup

Press the ▲▼ button to select **Sharpness** and press the ◀▶ button to adjust the value. Press the MENU button to return to the previous menu.

Advanced Setup

Press the ▲▼ button to select **Advanced** and press the OK button to enter.

In the menu, press the ▲▼ button to select the desired item and then press the OK button to confirm.

Press the MENU button to return to the previous menu.

NOTE: This feature is only available in VGA mode.

TV Function

Audio Setting

Press the MENU button once to enter the setup menu. Press the ▲▼ button to select **Audio** and press the OK button to enter the menu shown on the right. In the **Audio** setup menu, press the ▲▼ button to select the desired item and press the OK button to enter. Press the MENU button to return to the previous menu.

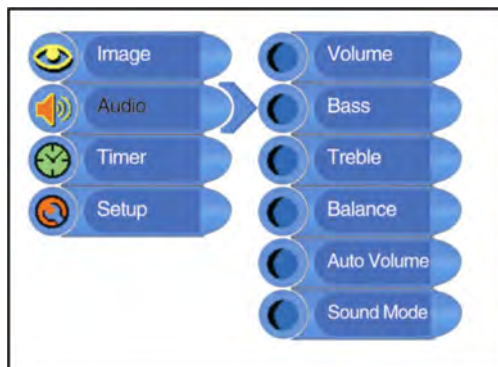

Volume Setup

Press the ▲▼ button to select **Volume** and press the ◀▶ button to adjust the level. Press the MENU button to return to the previous menu.

Bass Setup

Press the ▲▼ button to select **Bass** and press the ◀▶ button to adjust the level. Press the MENU button to return to the previous menu.

Treble Setup

Press the ▲▼ button to select **Treble** and press the ◀▶ button to adjust the level. Press the MENU button to return to the previous menu.

Balance Setup

Press the ▲▼ button to select **Balance** and press the ◀▶ button to adjust the level. Press the MENU button to return to the previous menu.

Auto Volume Setup

Press the ▲▼ button to select **Auto Volume** and press the OK button to enter. Press the ▲▼ button to select Off or On and then press the OK button to confirm your selection. Press the MENU button to return to the previous menu.

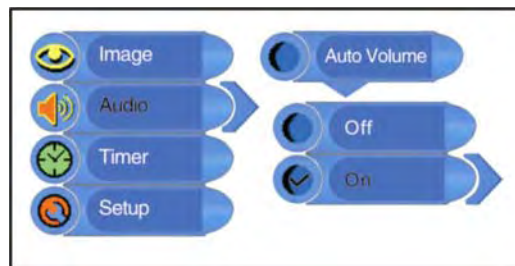

Sound Mode Setup

Press the ▲▼ button to select **Sound Mode** and press the OK button to enter. Press the ▲▼ button to select the desired item and press the OK button to confirm your selection. Press the MENU button to return to the previous menu.

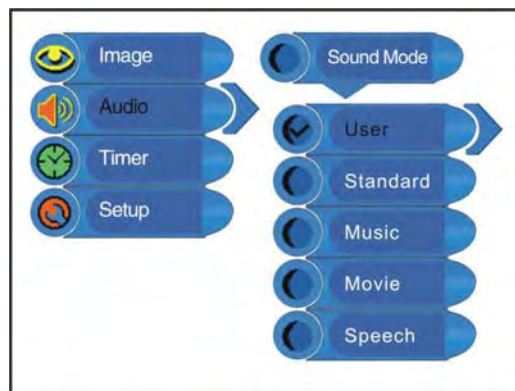

TV Function

Timer Setting

Press the MENU button to enter the setup menu. Press the ▲▼ button to select **Timer** and press the OK button to enter the menu shown on the right. In the Timer setup menu, press the▲▼ button to select 15Min, 30Min, 45Min, 60Min, 75Min, 90Min, 105Min, 120Min or Off. Press the MENU button to return to the previous menu.

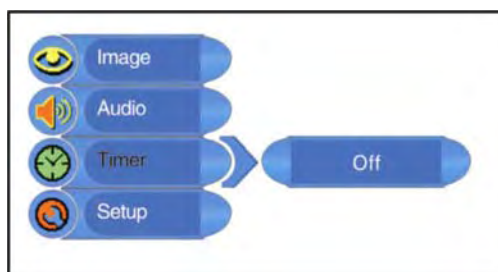

Setup Setting

Press the MENU button once to enter the setup menu. Press the▲▼ button to select **Setup** and press the OK button to enter the menu shown on the right. In the Setup menu, press the▲▼ button to select the desired item and press the OK button to enter. Press the MENU button to return to the previous menu.

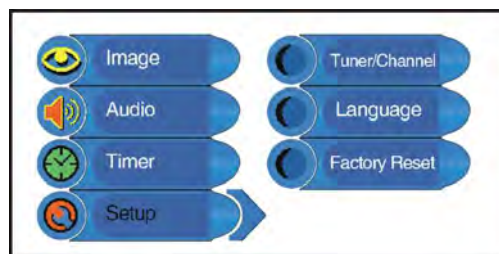

Tuner/Channel

Press the ▲▼ button to select the **Tuner/Channel** and press the OK button to enter the menu as shown on the right. Press the ▲▼ button to select the desired item and press the OK button to enter. Press the MENU button to return to the previous menu.

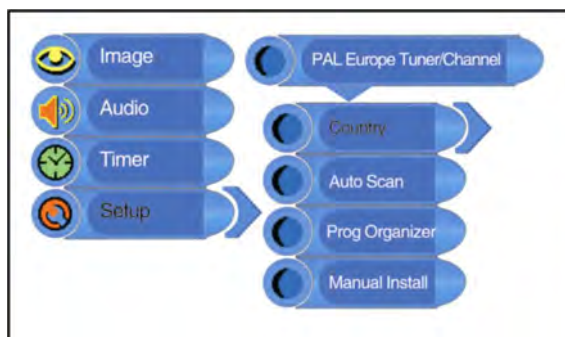

TV Function

Country Setup

Press the ▲▼ button to select **Country** and press the OK button to enter. Press the ▲▼ button to select the desired item and press the OK button to confirm your selection. Press the MENU button to return to the previous menu.



Auto Scan

Press the ▲▼ button to select the **Auto Scan**, press the OK button to start auto scan. The following will display on the screen:

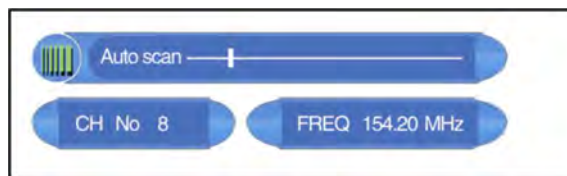

Auto scan will take a few minutes. When the tuning operation completes, the unit will exit and memorize the programs by sequence automatically.

During tuning, press the MENU button to exit the auto scan mode.

Prog Organizer

Press the ▲▼ button to select the **Prog Organizer** and press the OK button to enter the menu shown on the right.

In the Prog Organizer setup menu, press the ▲▼ button to select the desired item. Press the MENU button to return to the previous menu.

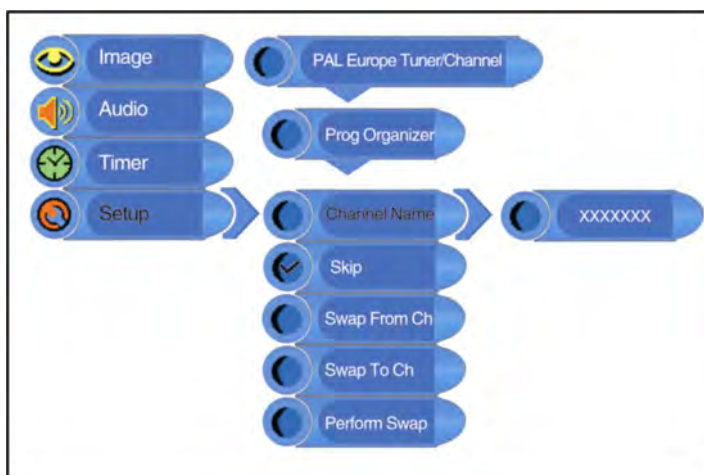

TV Function

Channel Name

Press the ▲▼ button to select the **Channel Name** and press the OK button to enter. Then press the ▲▼ button to select letters or press the number button to input numbers. Press the MENU button to return to the previous menu.

Skip

Press the ▲▼ button to select the **Add Program** and press the OK button to cancel the skip function which when using the CH ▲▼ button to select channels under normal playback status, it will play the channels in sequence. Press the MENU button to return to the previous menu.

Swap

Press the ▲▼ button to select **Swap from Ch** and press the OK button to enter. Press the number buttons to select program number. Repeat the above operations to **Swap To Ch**. Then Press the ▲▼ button to select **Perform Swap** and press the OK button to confirm.

Manual Install

Press the ▲▼ button to select the **Manual Install** and press the OK button to enter the menu shown on the right.

In the Manual Install setup menu, press the ▲▼ button to select the desired item. Press the MENU button to return to the previous menu.

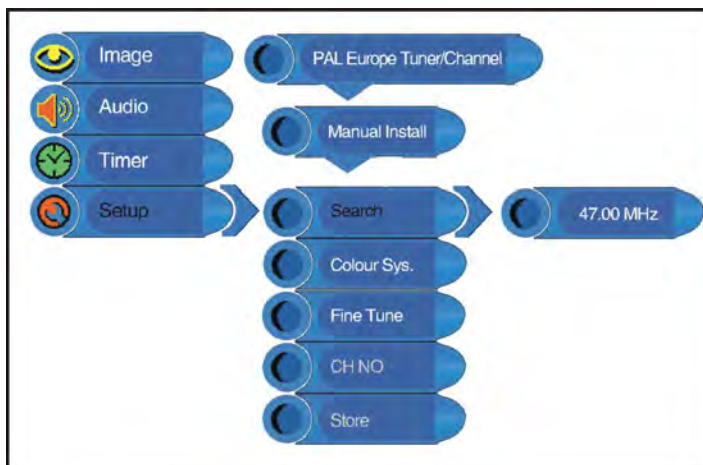

Search

Press the ▲▼ button to select **Search** and press the ► or ◀ to start searching forward or backward. Press the MENU button to return to the previous menu.

Color Sys. (Color System)

Press the ▲▼ button to select **Color Sys.** and press the OK button to enter. Press the MENU button to return to the previous menu.

TV Function

Fine Tune

Press the ▲▼ button to select **Fine Tune** and press the OK button to enter. Press the ► or ◀ controls to start fine tuning forward or backward. Press the MENU button to return to the previous menu.

This feature allows you to make minor adjustments to the integrated electronic tuner's ability to tune in weak broadcast signals or, where applicable, solve minor irregularities in cable channel tuning parameters.

CH NO (Channel Number)

Press the ▲▼ button to select **CH NO** and press the OK button to enter. Press the number buttons to enter the channel number. Press the MENU button to return to the previous menu.

Store

Press the ▲▼ button to select **Store** and press the OK button to store the above operations.

Note: The “CH NO” and “Store” items only function when the program is searched out.

Language

Press the ▲▼ button to select the **Language**, press the OK button to enter the setup, press the ▲▼ button to select item and press the OK button to confirm your selection. Press the MENU button to return to the previous menu.

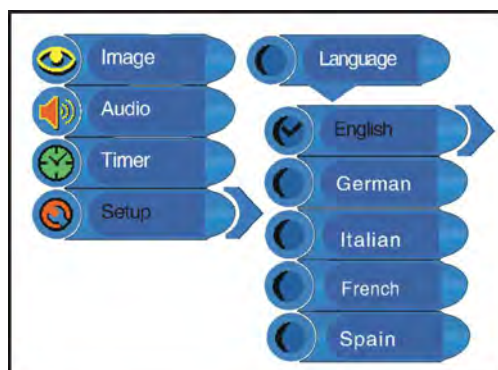

Factory Reset

Press the ▲▼ button to select the **Factory Reset** and press the OK button to enter the setup, press the ▲▼ button to select Yes or No. Press the OK button to confirm your selection. Press the MENU button to return to the previous menu.

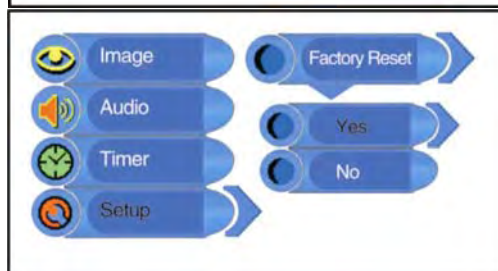

NICAM Function

The unit support NICAM function under TV mode.

Under NICAM TV broadcast:

1. When receiving stereo audio signals, press the STEREO/AUDIO button on the remote control repeatedly to shift the sound tracks between **Nicam Stereo** and **Mono** and the screen will appear corresponding display as shown below:



2. When receiving bilingual audio signals, press the STEREO/AUDIO button on the remote control repeatedly to shift the sound tracks among **Nicam I**, **Nicam II**, **Nicam I+II** and **Mono** and the screen will appear corresponding display as shown below:



3. When receiving mono audio signals, press the STEREO/AUDIO button on the remote control repeatedly to shift the sound tracks between **Nicam Mono** and **Mono** and the screen will appear corresponding display as shown below:



Under A2 TV broadcast:

1. When receiving stereo audio signals, press the STEREO/AUDIO button on the remote control repeatedly to shift the sound tracks between **Stereo** and **Mono** and the screen will appear corresponding display as shown below:



2. When receiving bilingual audio signals, press the STEREO/AUDIO button on the remote control repeatedly to shift the sound tracks among **I**, **II** and **I+II** and the screen will appear corresponding display as shown below:



3. When receiving mono audio signals, press the STEREO/AUDIO button on the remote control to display sound track **Mono** on the screen.



Other Function

External AV Input Function

The unit has external AV input function. It supports COMPOSITE, S-VIDEO and COMPONENT modes. Use the audio, video, and S-Video cables to connect the unit to the external AV signal source such as recorder, video camera, satellite receiver or game player etc. Turn on the unit and the external AV signal source. Press the INPUT button to shift to the corresponding mode: COMPOSITE, S-VIDEO or COMPONENT. This allows you to set up the menu in a certain mode.

Computer Screen Function

The TFT LCD screen of the unit can be used as the computer screen. Take the steps of connecting the unit to the PC and you can set up the menu.

You should set the PC's resolution to: 1024 x 768@60Hz.

The operation of these menus in COMPOSITE, S-VIDEO, COMPONENT and VGA modes is the same as in TV mode. Please refer to the introduction in "TV Function".

Note: Some of these menus are not available in these modes.

Troubleshooting

PROBLEM	POSSIBLE SOLUTION
There is no sound.	Make sure system connection is correct. Make sure the speakers are not muted. In the TV mode, set the correct sound mode.
LCD is not displaying a picture.	Make sure the unit is turned on and all connections are correct. Make sure the power adapter is correctly connected.
There is no picture or picture moves up and down.	Check if the connections with the external AV signal source are correct. Correctly change the setting in the picture menu. Make sure the video type input signal is corresponding to the unit. Make sure the unit is turned on and in correct video type.
The remote control does not work.	Make sure there are no obstructions between the remote control and the player. Make sure the remote control is pointing at the LCD unit. Make sure batteries are inserted and the polarity is correct. Make sure batteries are not weak.

Other Notes:

Static or other external interfere may cause the player to behave abnormally. If this occurs, unplug the power cord from the outlet and plug it in again to reset the LCD. If the problems persist, then please disconnect the power and consult a qualified technician.

Specifications

TFT-LCD Resolution	1024 x 768
TFT-LCD Screen Size	15 inches
Power	AC100~240V (50/60Hz) DC 12V 4A
Power Consumption	< 40W
Dimension	345 × 84 × 390mm (LXWXD)
Weight	About 5.8 kg
Ambient Temperature	10~45

DESIGN AND SPECIFICATIONS ARE SUBJECT TO CHANGE WITHOUT NOTICE

"Polaroid" and "Polaroid and Pixel" are trademarks of Polaroid Corporation, Waltham, MA, USA.

For service, support and warranty information, see your warranty card or visit www.polaroid.com.

